

# Data Sheet



Article number: 2011461680

Description: E+G Stainless steel lock pin  
GN 114.6-16-80

## Measures

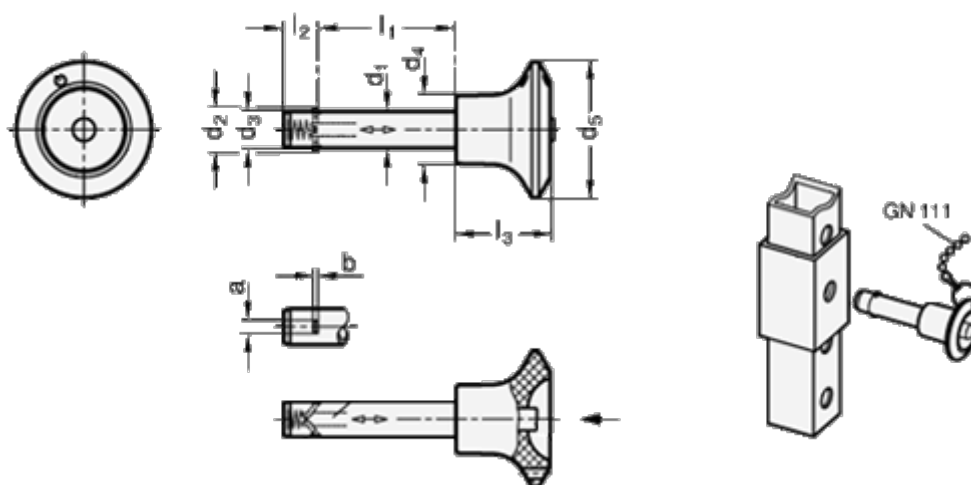

|           |                    |
|-----------|--------------------|
| a = 113.0 | l3 = 32            |
| d1 = 16   | Resilience (N) = 5 |
| d2 = 19.9 |                    |
| d3 = 15.9 |                    |
| d4 = 22.0 |                    |
| d5 = 40   |                    |
| l1 = 80   |                    |
| l2 = 14.2 |                    |